

Data Sheet

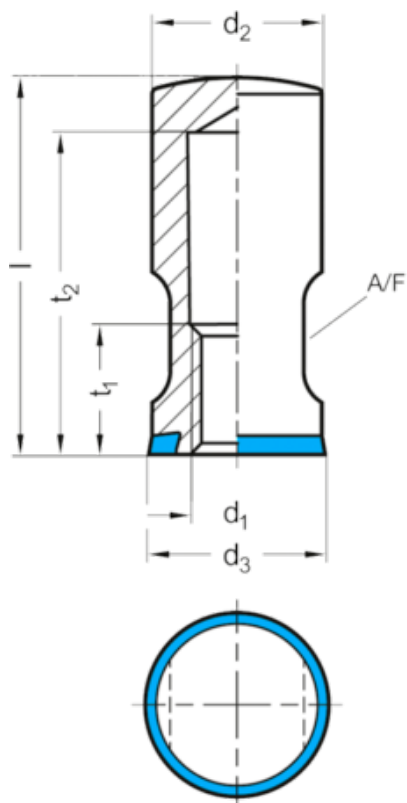

Article number: 20201M2474E
Description: GN 20.1-M24-74-E
Stainless Steel-Cover sleeves
Note: Hygienic Design

Measures



Application example

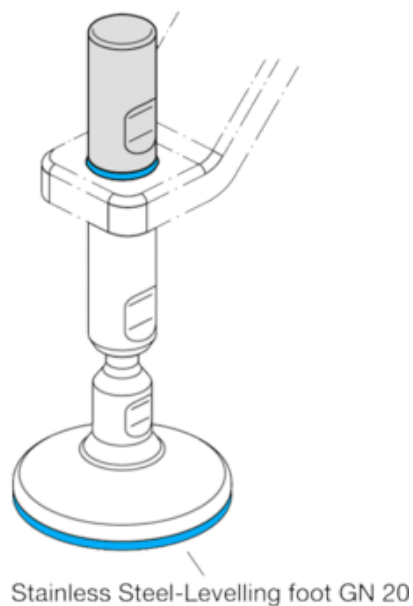

A/F	= 30
d1	= M 24
d2	= 36
d3	= 36.8
l	= 74
t1	= 30.5
t2	= 65
Weight in (g)	= 352